

EQUIPAMIENTOS PARA
entorno urbano



INSTRUCCIONES DE MONTAJE

Cangrejo Ermitaño

Versión para suelo de caucho

REF.81343

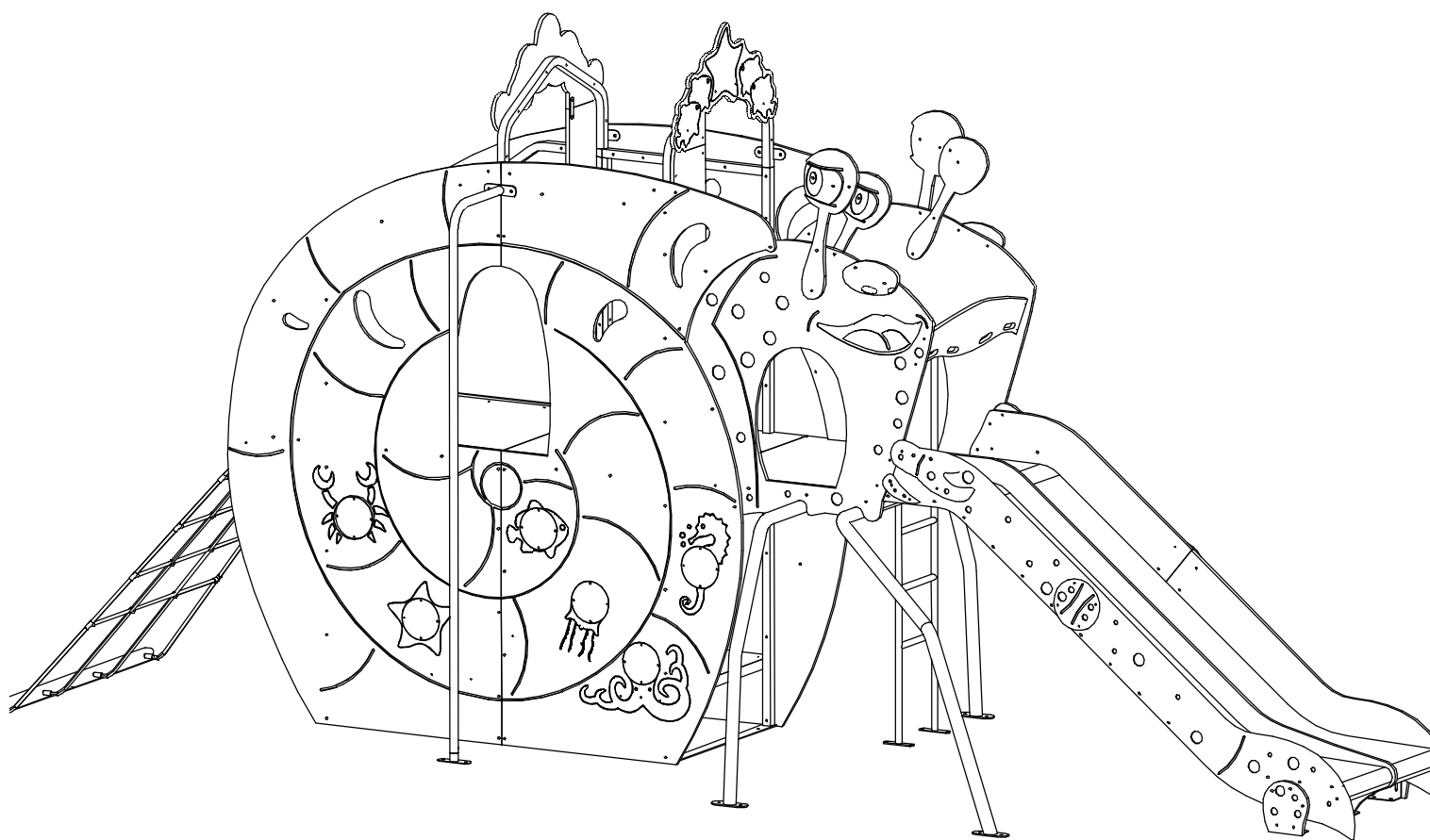

Partes premontadas

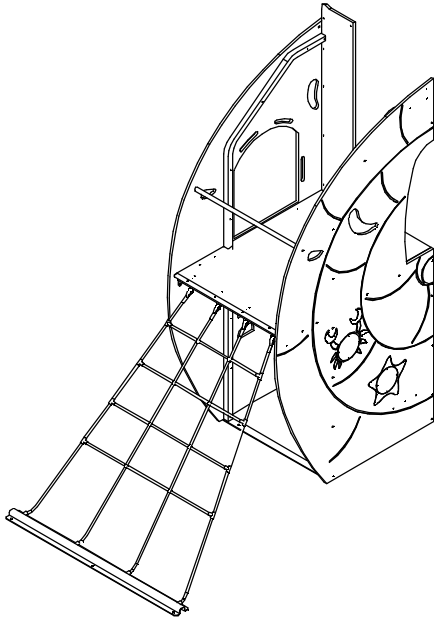

Parte trasera x1

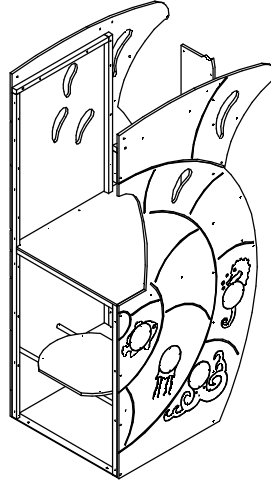

Parte delantera x1

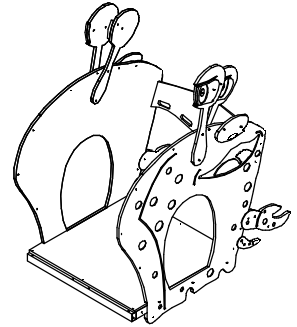

Cabeza x1

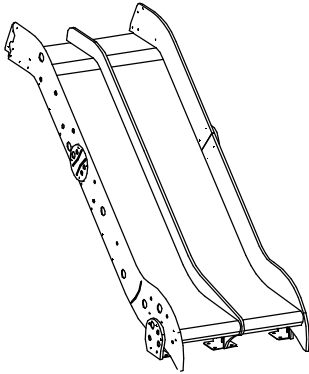

Tobogán doble x1

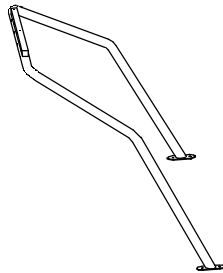

Pata delantera x1

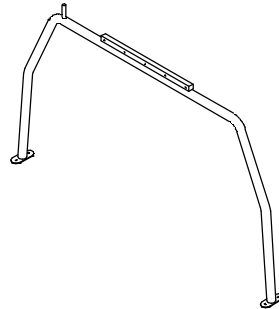

PataTrasera x1

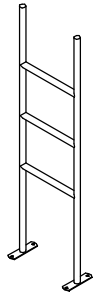

Escalera x1

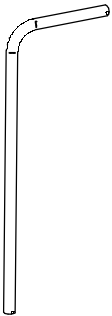

Pasamanos escalera x1



58134409
Barra de bomberos x1

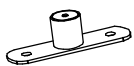

58134322
Anclaje barra de bomberos x1

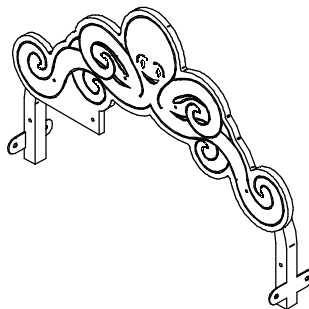

Arco Superior trasero x1

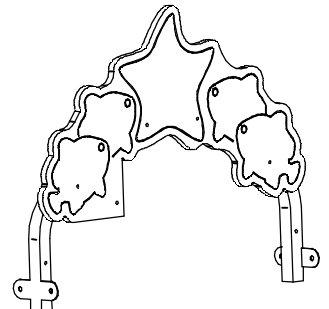

Arco Superior delantero x1

1º

X13 Tornillo DIN 933 M8x75

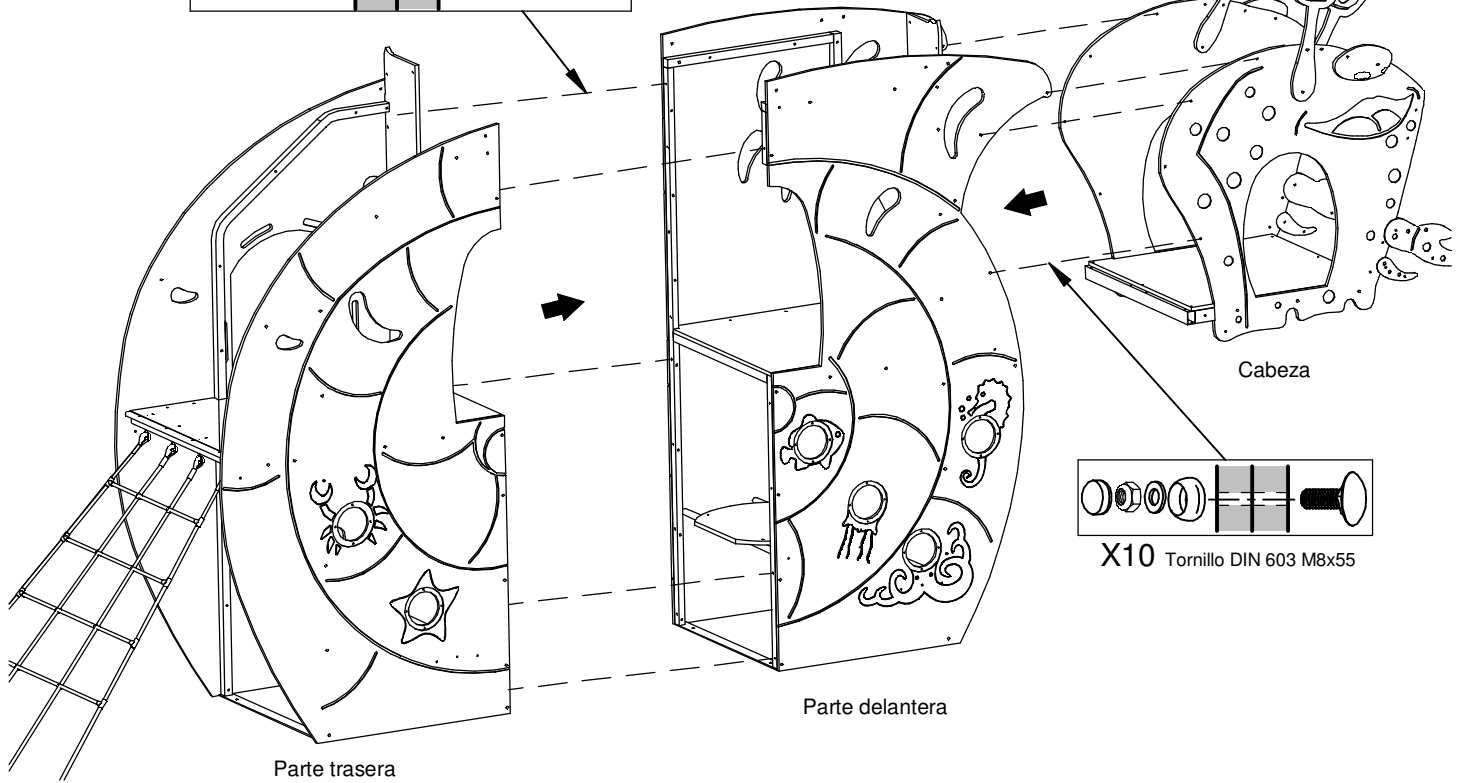

X10 Tornillo DIN 603 M8x55

2º

X8 DIN 603 M8x40

Cabeza del tornillo hacia el exterior

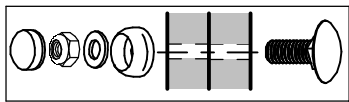

Arco superior trasero

Arco superior delantero

X2 Tornillo DIN 933 M8x80

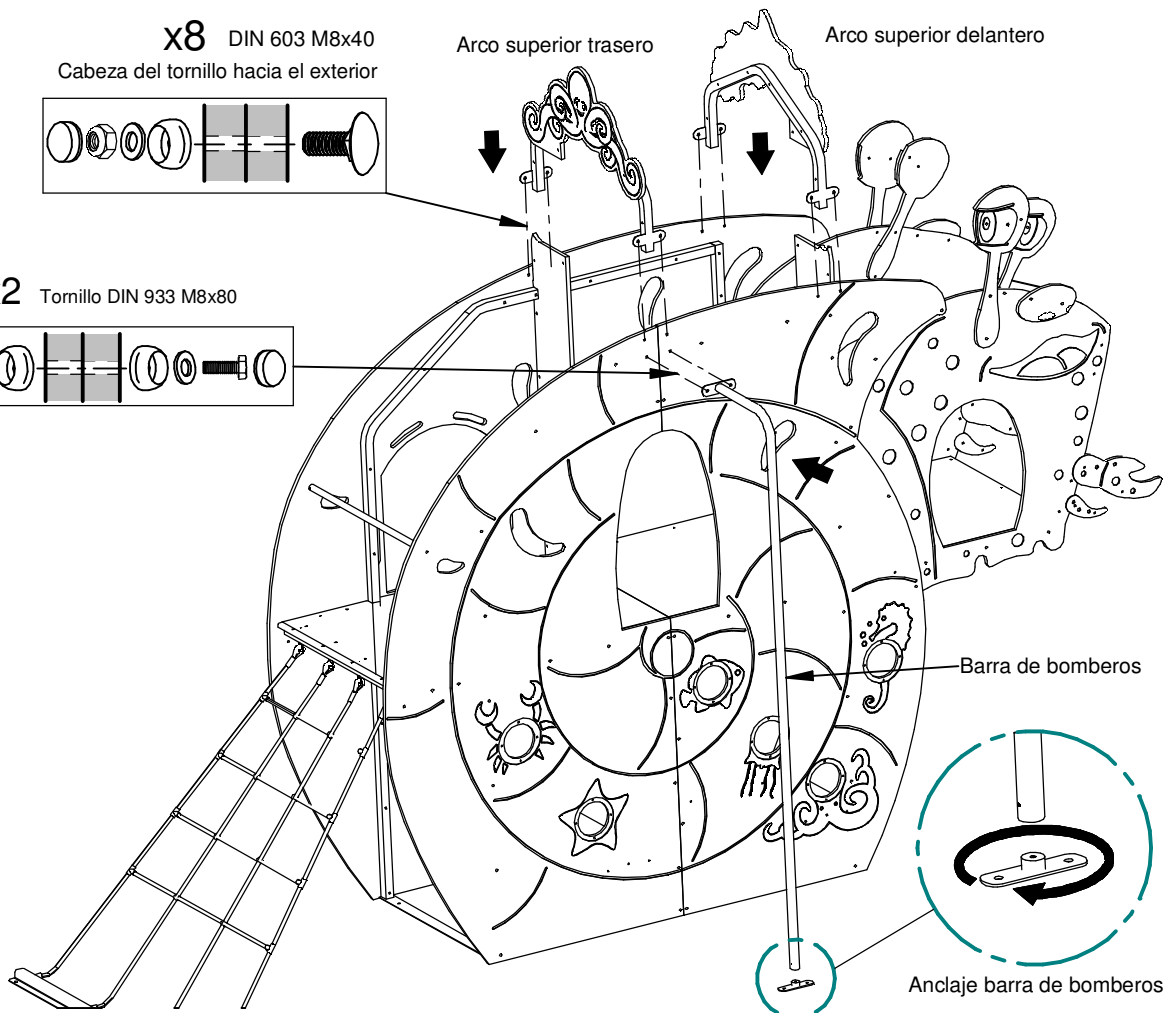
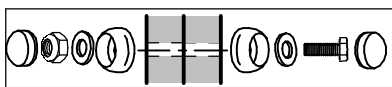

Barra de bomberos

Anclaje barra de bomberos

3º

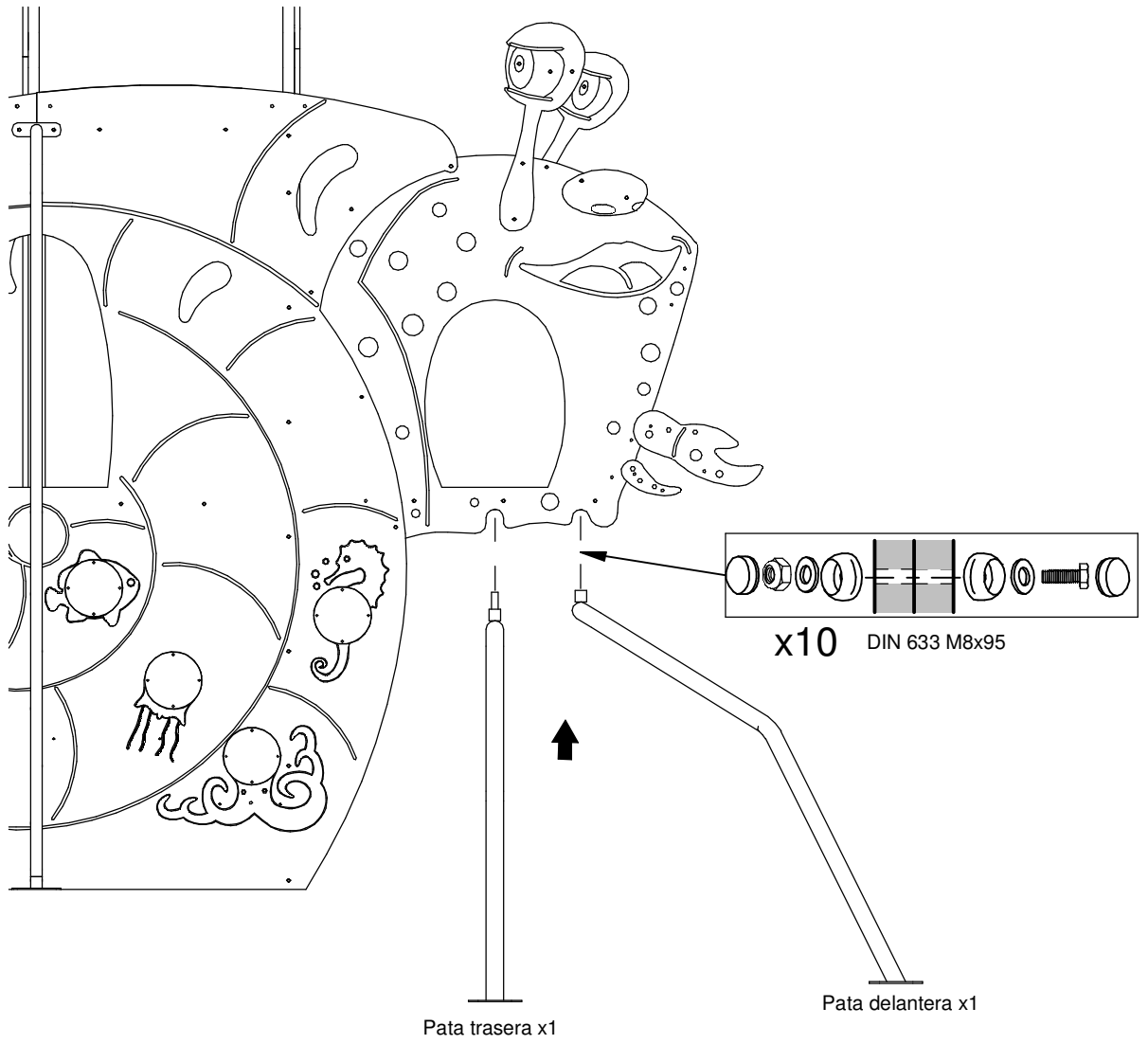

4º

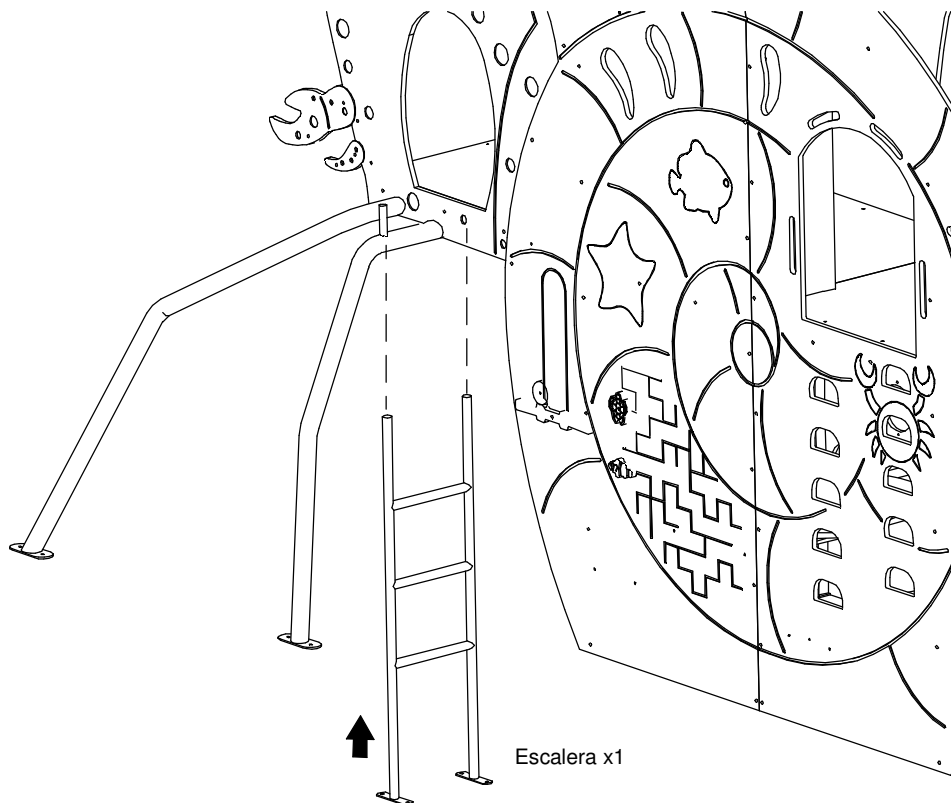

5º

Pasamanos
escalera

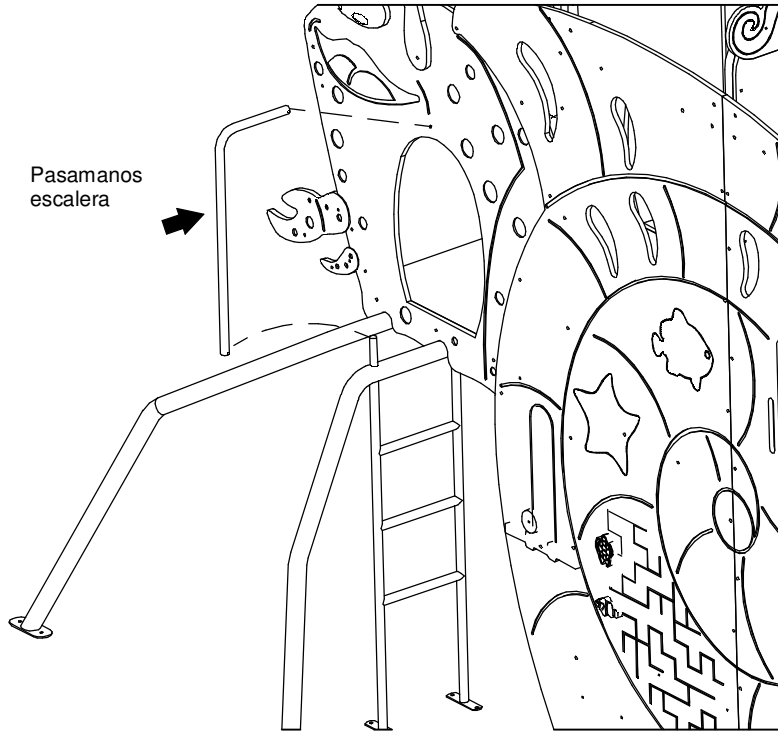

6º

x6 DIN 633 M8x60

Tobogán doble

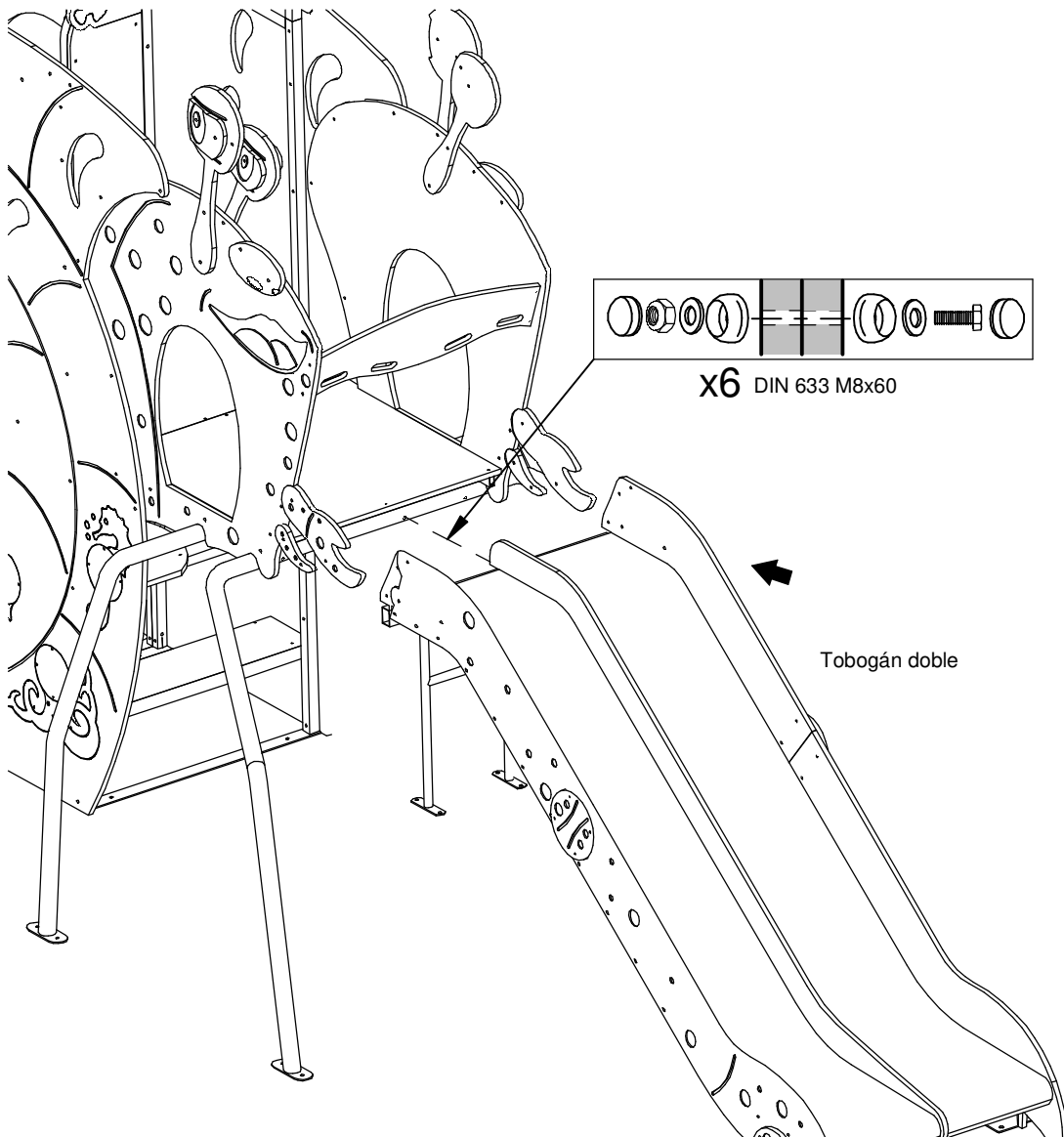

7º

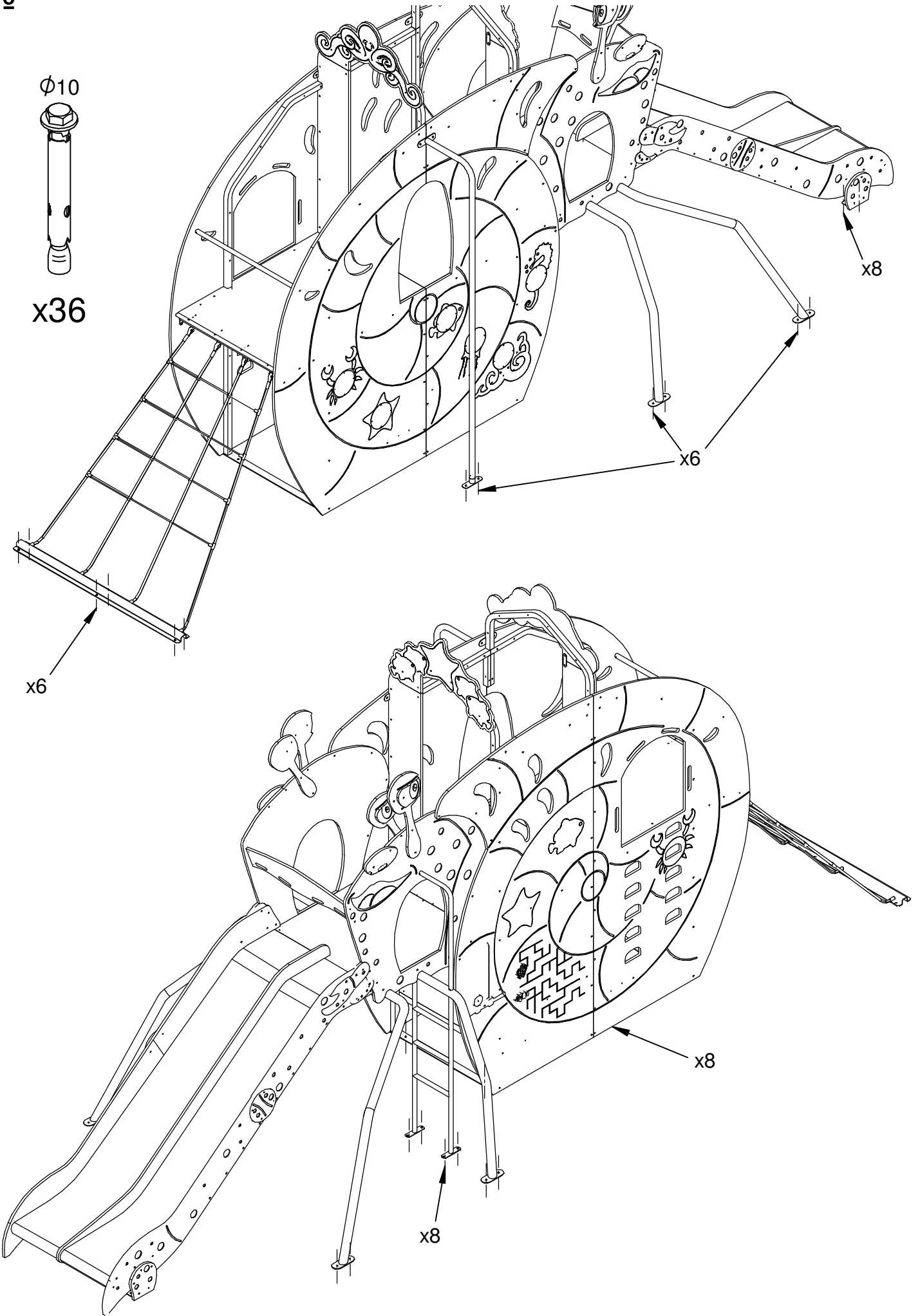

EQUIPAMIENTOS PARA
entorno urbano



INSTRUCCIONES DE MONTAJE

Cangrejo Ermitaño

Versión para Arenero

REF.81343

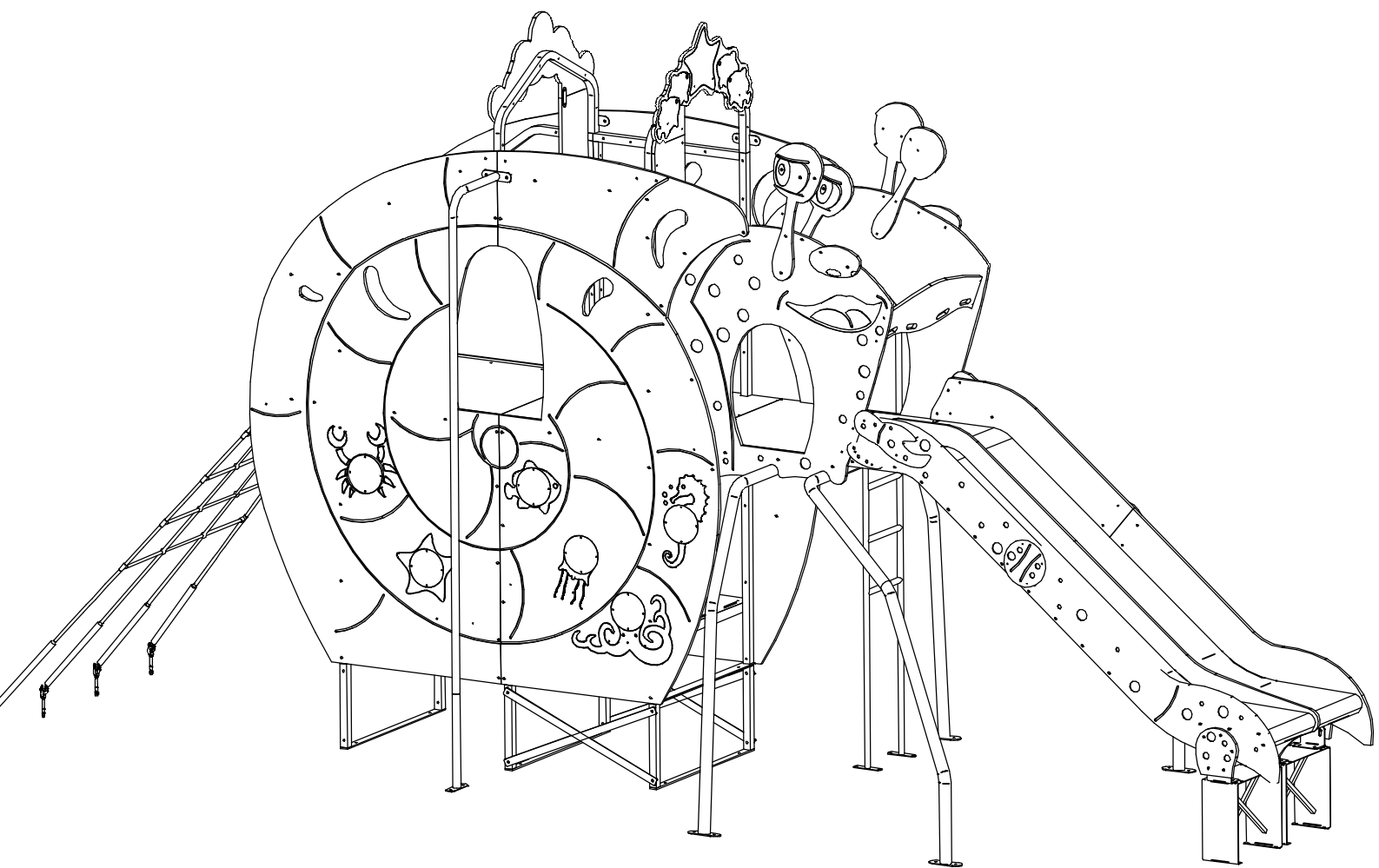

Partes premontadas

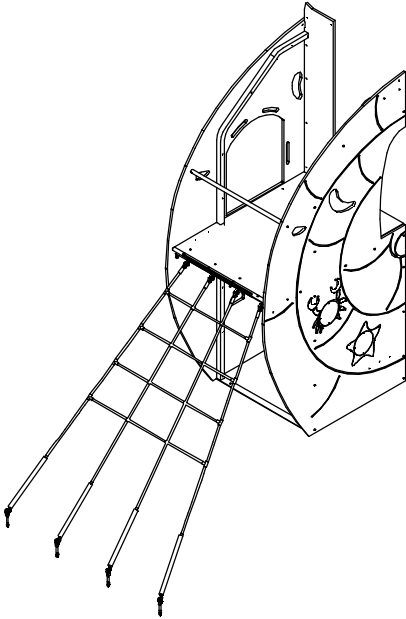

Parte trasera x1

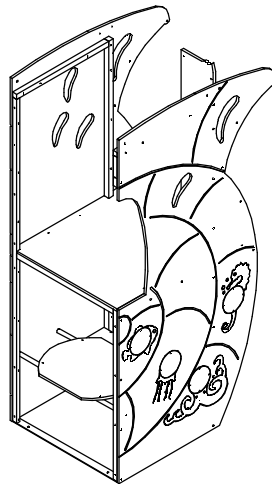

Parte delantera x1

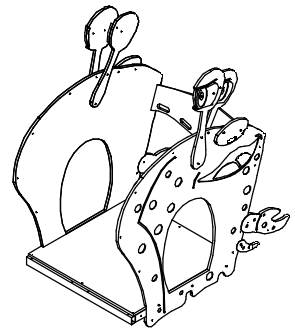

Cabeza x1

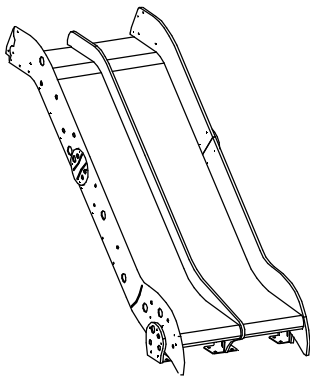

Tobogán doble x1

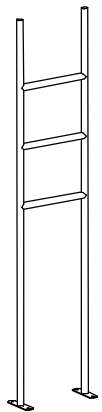

Escalera ARENERO x1

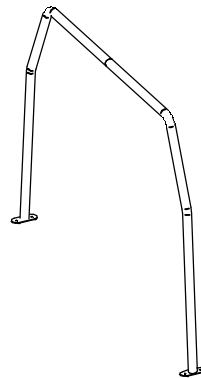

PataTrasera ARENERO x1

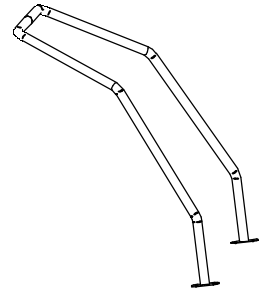

Pata delantera ARENERO x1

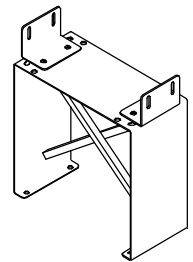

Anclaje suelo ARENERO x2

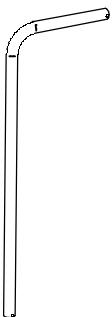

Pasamanos escalera x1

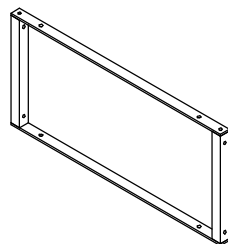

Anclaje chapa ARENERO x3



Pletina larga chapa ARENERO x4

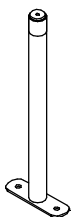

Anclaje barra de bomberos ARENERO x1



58134409 Barra de bomberos x1

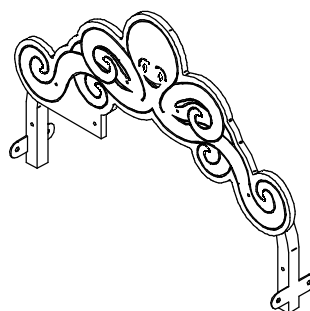

Arco Superior trasero x1

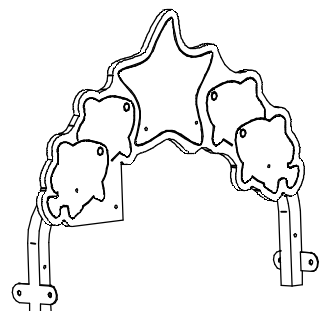

Arco Superior delantero x1

1º

X13 Tornillo DIN 933 M8x75

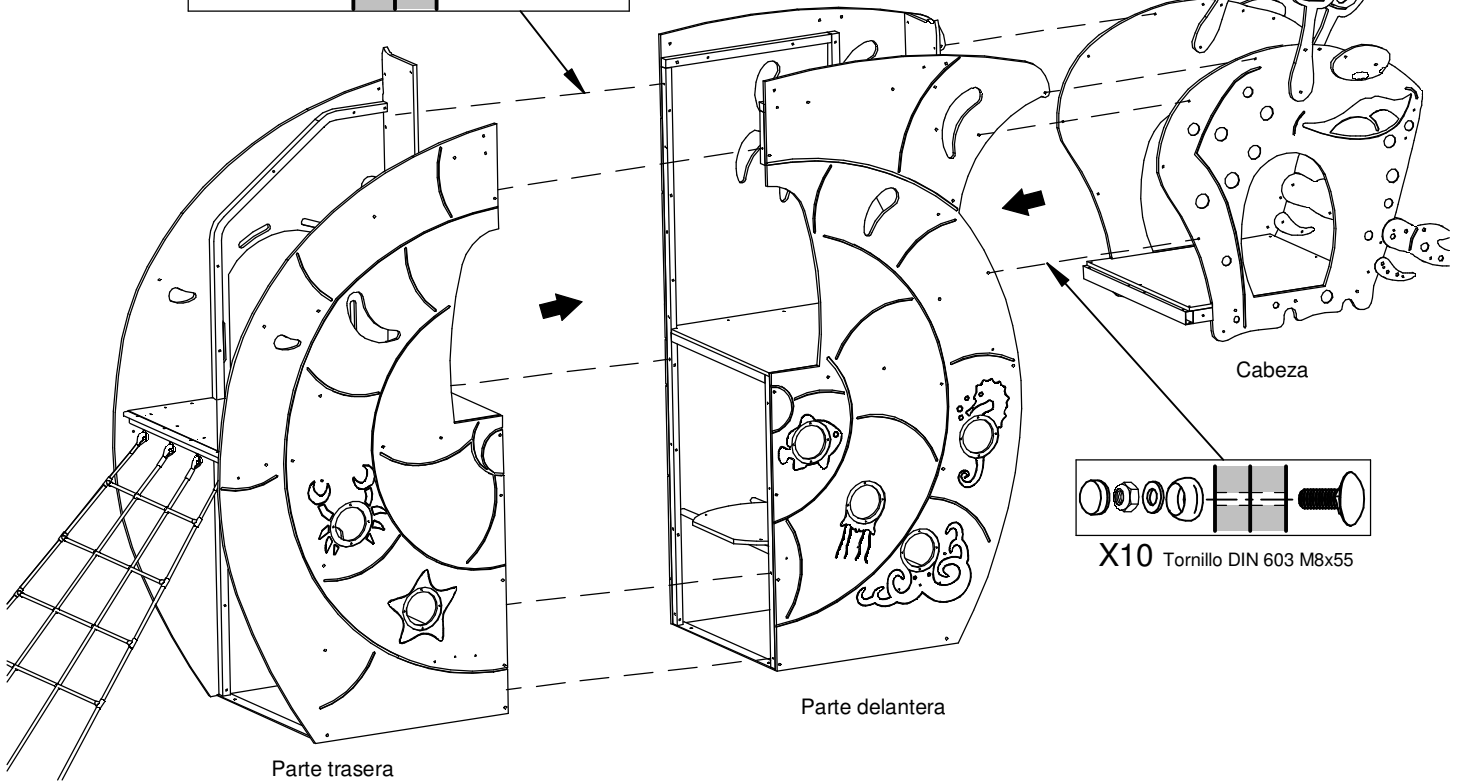
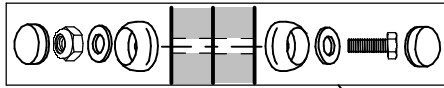

2º

X8 DIN 603 M8x40

Cabeza del tornillo hacia el exterior

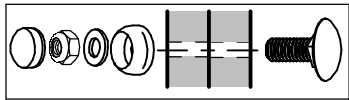

X2 Tornillo DIN 933 M8x80

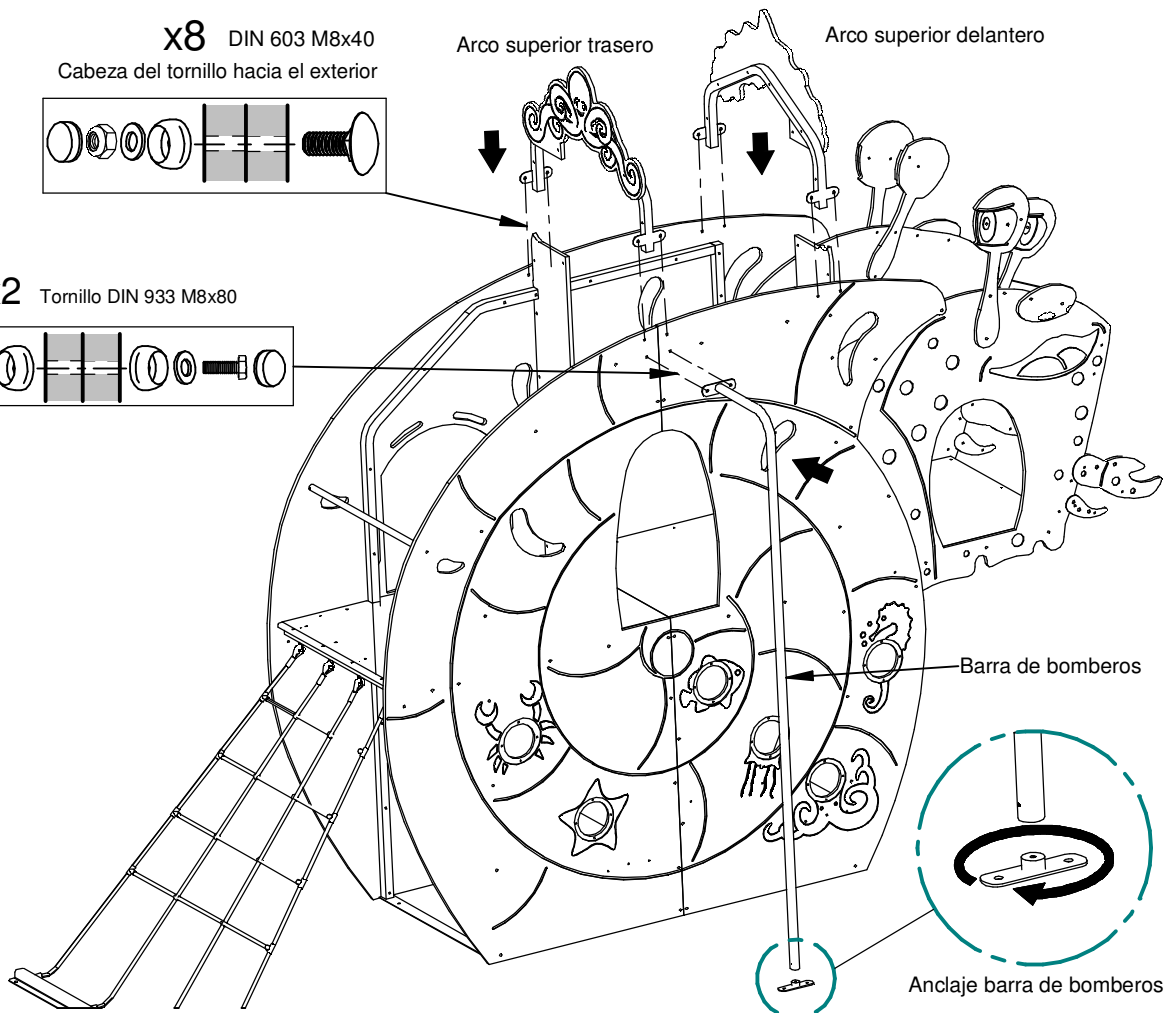
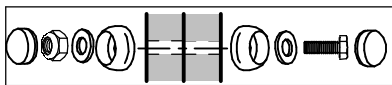

3º

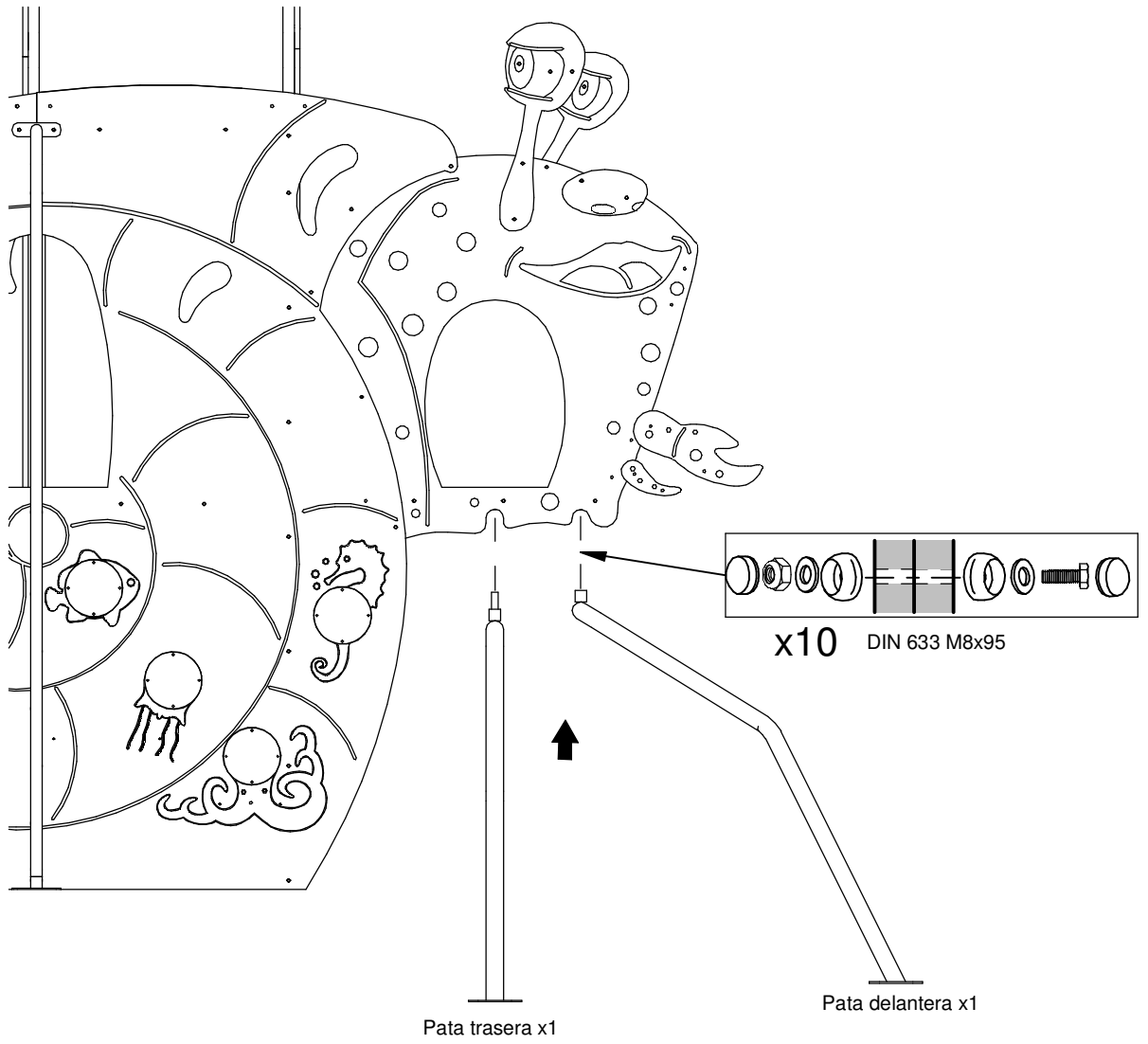

4º

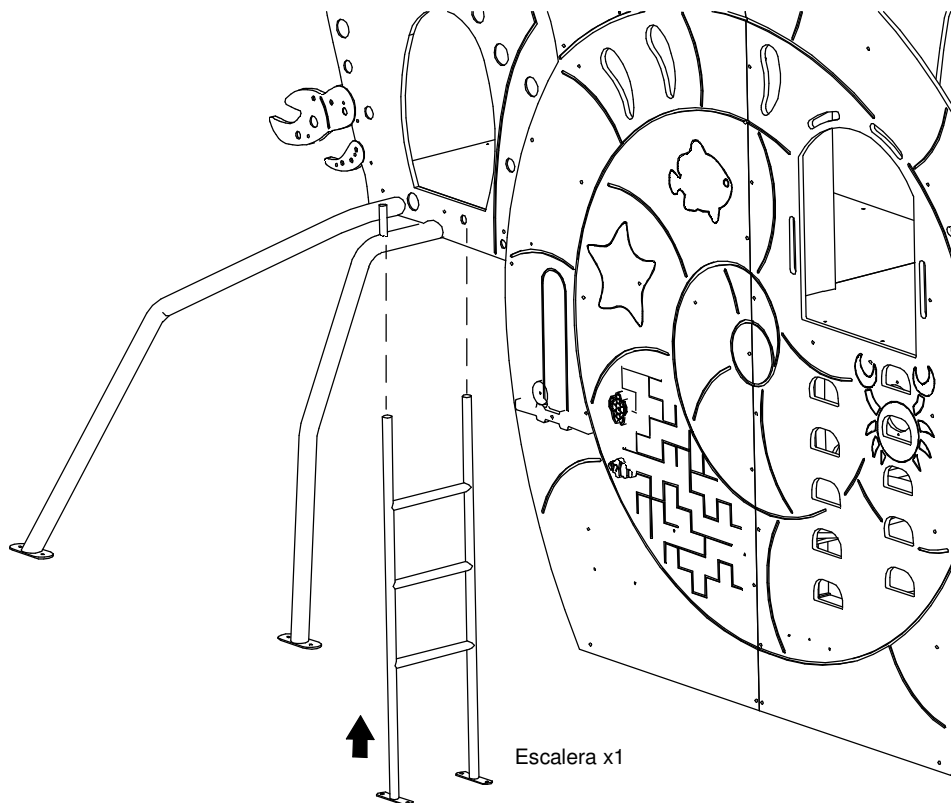

5º

Pasamanos
escalera

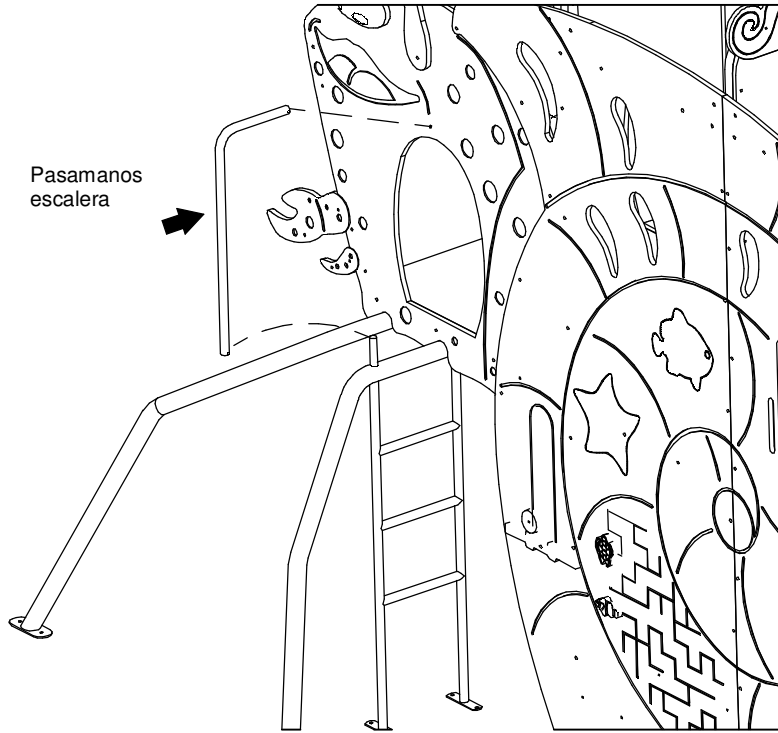

6º

x6 DIN 633 M8x60

Tobogán doble

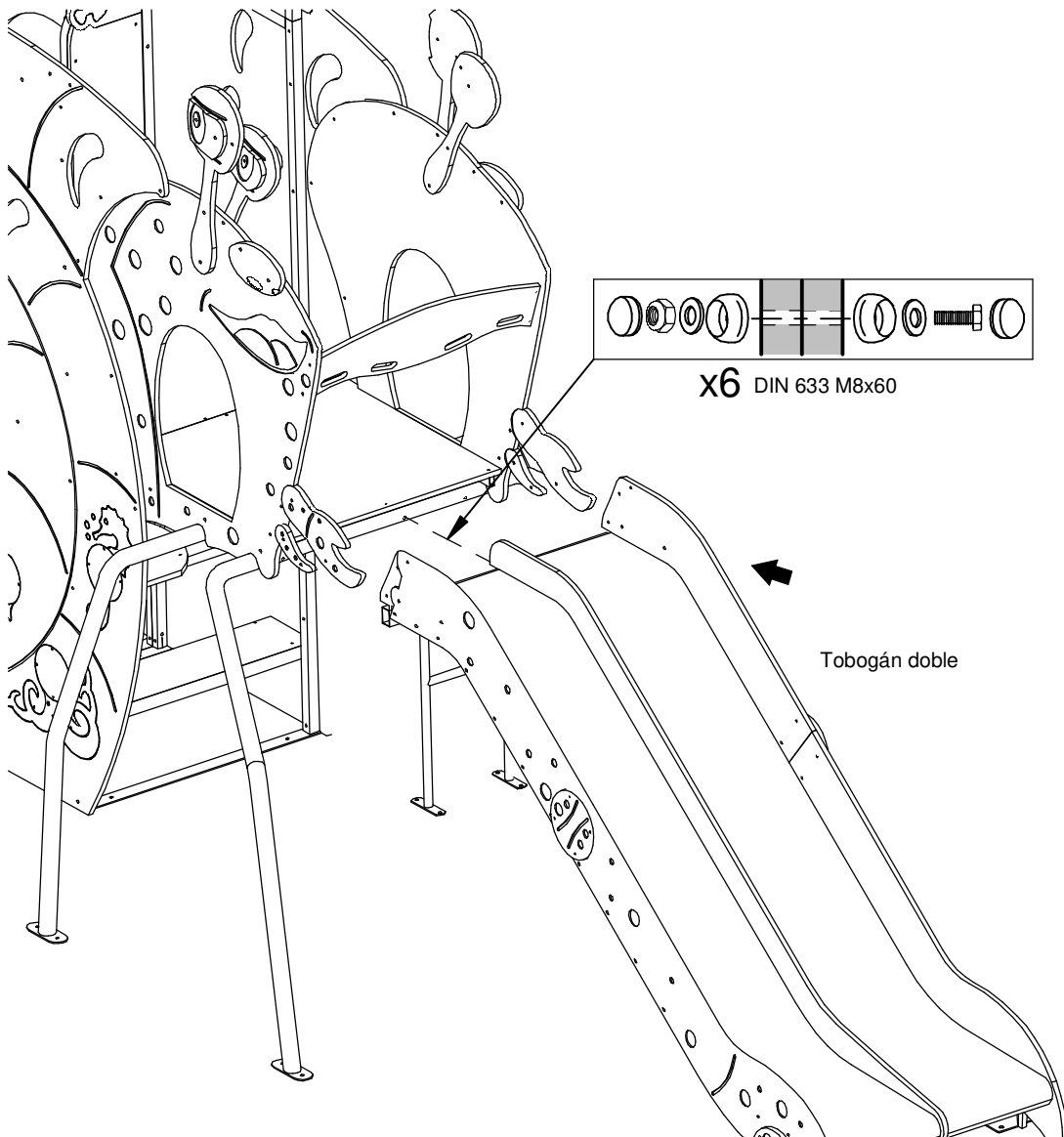

7º

