



INSTRUCCIONES DE MONTAJE

Mecedor Mini Dúo

Suelo de caucho Ref.81427 / 81443 / 81444

Arenero Ref.81447 / 81448 / 81449

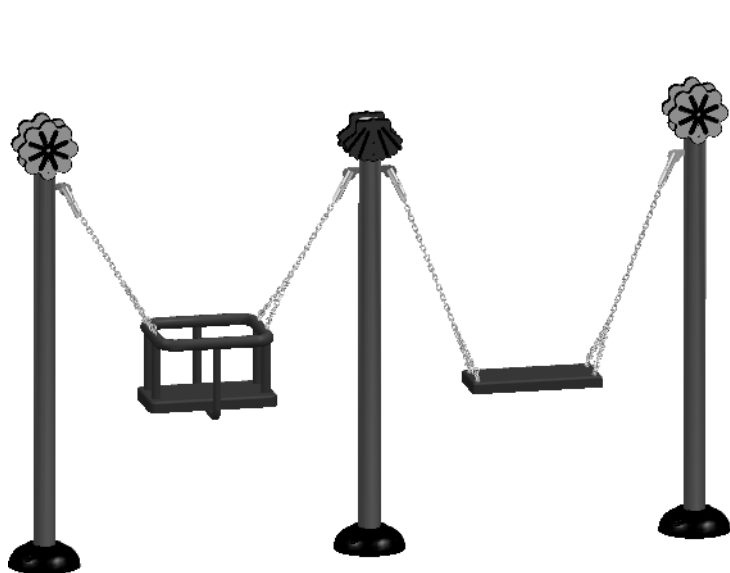

81427 Mecedor Mini Dúo asiento mixto

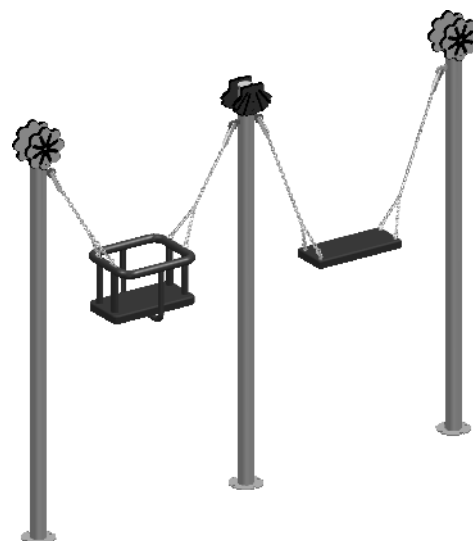

81447 Mecedor Mini
dúo asiento mixto arenero

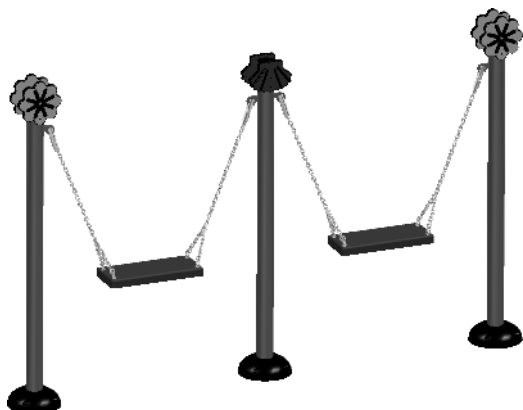

81443 Mecedor Mini Dúo asiento plano

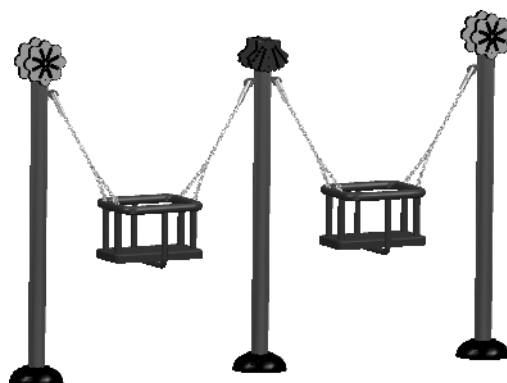

81444 Mecedor Mini Dúo asiento cuna

Mecedor Mini Dúo

Partes

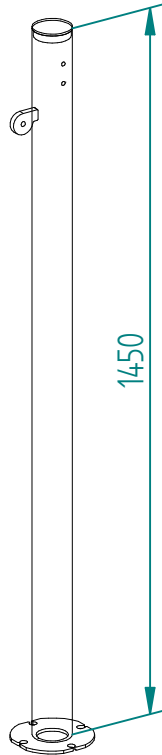

58142701
Poste lateral
cimentación x2

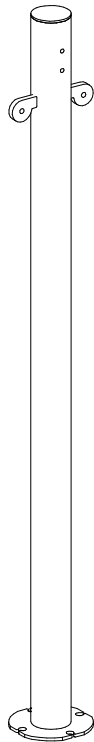

58142702
Poste central
cimentación x1



58144501
Poste lateral
arenero x2

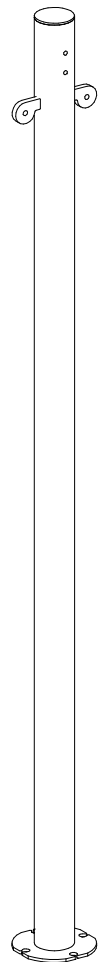

58144502
Poste central
arenero x1



Cuna x2 (Según Versión)

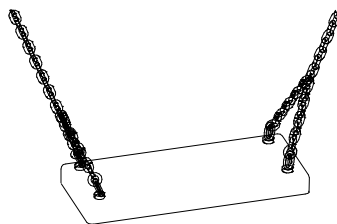

Columpio x2 (Según Versión)

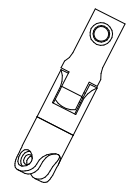

Cardán x4

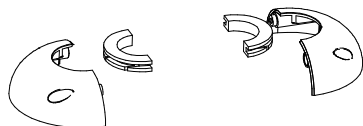

Embellecedor x3 (según versión)

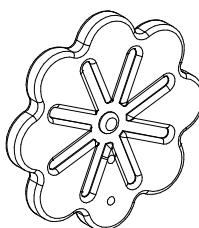

Decoración Flor x2

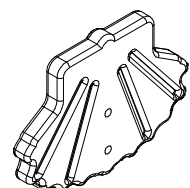

Decoración concha x1

1

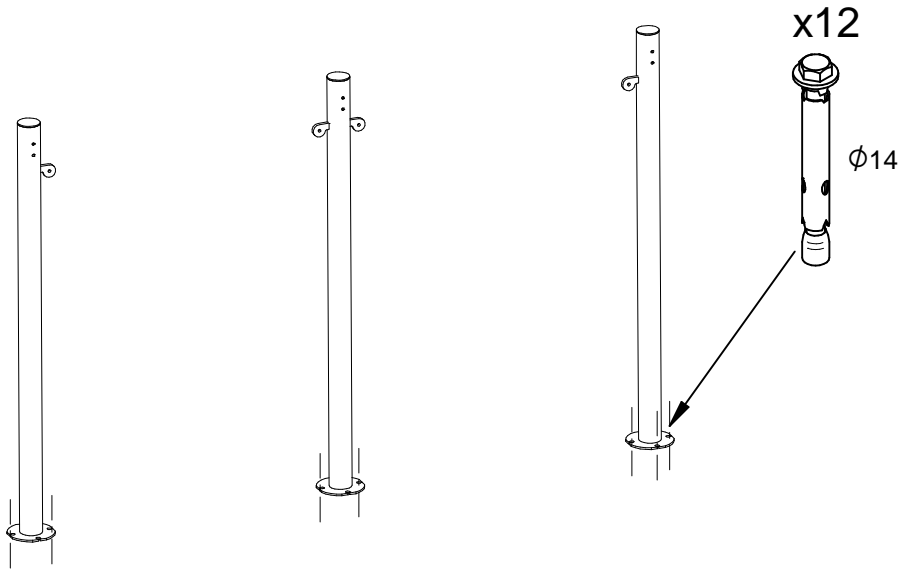

2

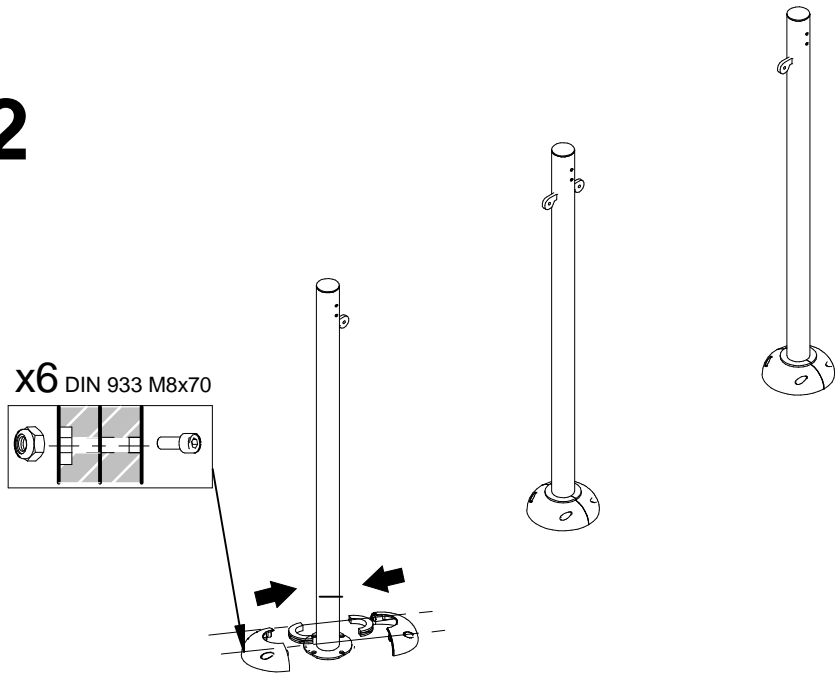

3

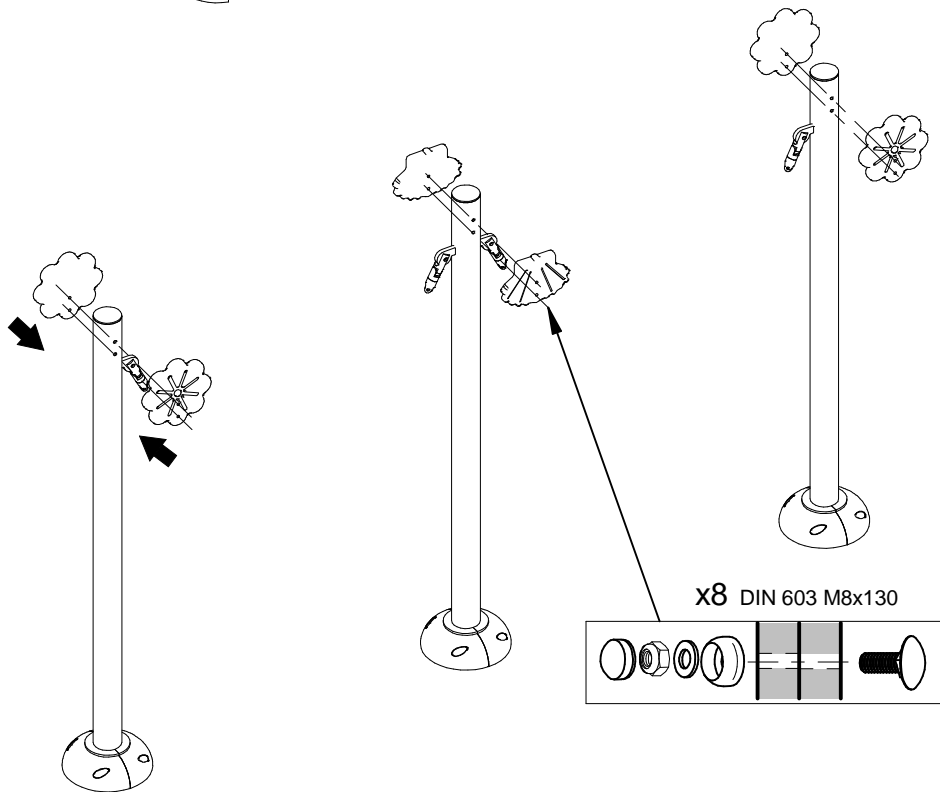

4

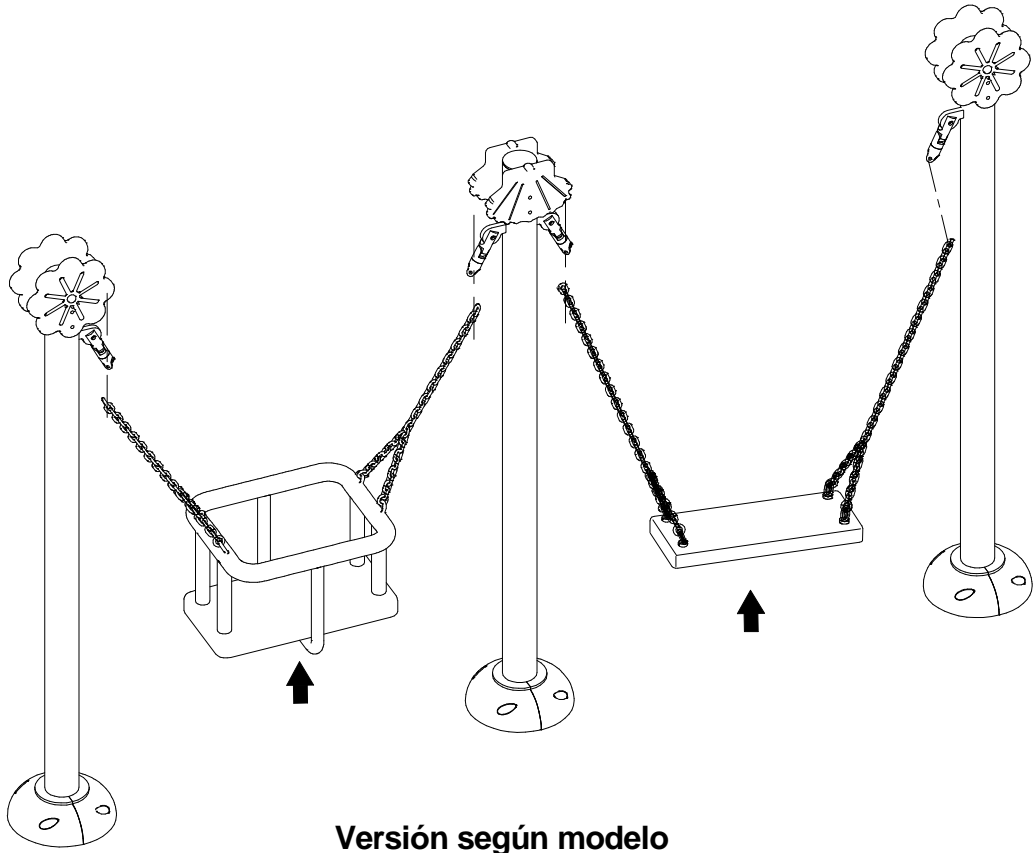

Versión según modelo